

PROIZVODNJA I MONTAŽA ČELIČNIH KONSTRUKCIJA
PROIZVODNJA I MONTAŽA KONSTRUKCIJE I OPREME ELEKTROFILTERA
REMONT I MONTAŽA KOTLOVSKE OPREME
MONTAŽA TEHNOLOŠKE OPREME
TRANSPORTNA I DIZALIČNA SREDSTVA

MANUFACTURING AND ERECTION OF STEEL STRUCTURES
MANUFACTURING AND ERECTION OF STEEL STRUCTURES AND EQUIPMENT FOR ELECTROSTATIC PRECIPITATORS
OVERHAUL OF STEAM BOILERS AND ERECTION OF EQUIPMENT
ERECTION AND INSTALLATION OF TECHNOLOGICAL EQUIPMENT
TRANSPORT AND CRANES



Bosnamontaža A.D.
PRIJEDOR

PREDUZEĆE ZA MONTAŽNO PROIZVODNE I USLUŽNE DJELATNOSTI
COMPANY FOR PRODUCTION, ERECTION AND SERVICE ACTIVITIES

Više od pola vijeka duga tradicija, bogata iskustva, snažan kadrovski potencijal i oprema čine nas jednom od vodećih firmi u oblasti proizvodnje i montaže čeličnih konstrukcija i razne opreme u našoj republici pa i šire. Počevši sa vršenjem usluga, usmjeravajući proizvodnu orijentaciju u oblast proizvodnje i montaže čeličnih konstrukcija, sve većim uključivanjem u proizvodnju razne opreme za industriju i poljoprivredu, razvijajući projektnu funkciju "Bosnamontaža" a.d. Prijedor je danas sposobna da tržištu nudi kompleksne usluge sistemom inženjeringa. Dostignut stepen razvoja, do sada ostvareni proizvodni rezultati, opremljenost, postojeći kadrovski potencijal, ulaganje značajnih sredstava u školovanje vlastitih kadrova te spremnost radnih ljudi da se i dalje angažuju na ostvarenju planskih zadataka garancija su daljnjeg uspješnog rasta i razvoja. Nalazimo se u Prijedoru koji je na sjeverozapadu Bosne i Hercegovine, udaljeni svega 30 km od autoputa Beograd – Zagreb. Pošto uz vlastiti krug prolazi industrijski kolosjek, imamo izuzetno povoljne uslove za, kako dopremu sirovina, tako i otpremu gotovih proizvoda. Sve gore navedeno je rezultiralo ovlaštenjima od Ministarstva energetike, Ministarstva građevine, kao i potrebnim TÜV licencama za bavljenje osnovnim djelatnostima.

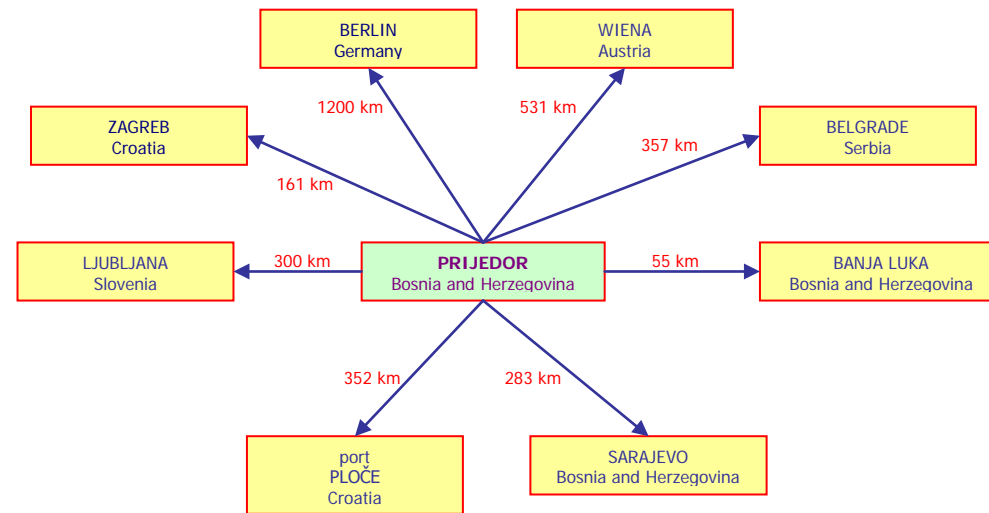
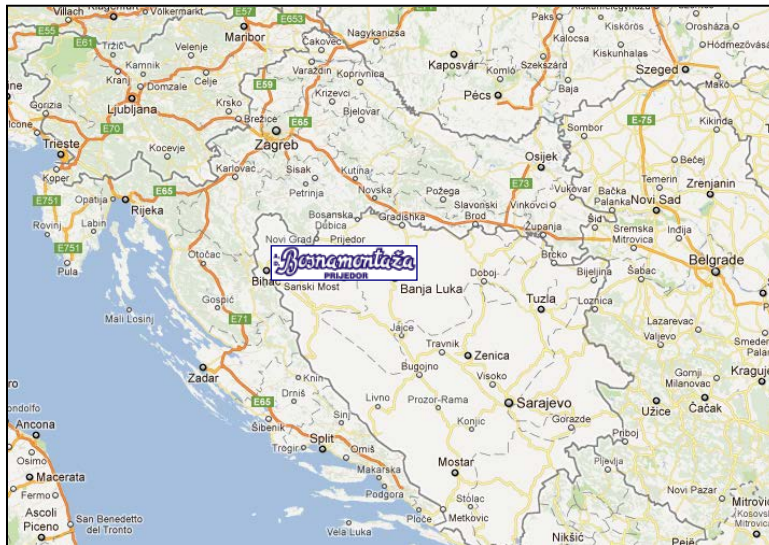

A tradition of more than half a century, rich experiences, competent and proficient personnel, coupled with modern equipment make this company one of the leading organizations in the area of manufacturing and erection of steel structures and installation of various equipment, in Bosnia and Herzegovina and region. The firm has been faced with many problems and difficulties on it's way of development. However, by relying on it's own potentials and capacities, it's succeeded to grow stronger from year to year, in profitable business and personnel structure.

We offer various services to market, manufacturing and erection of steel structures particularly designd for industry and agriculture; supporting these activities with a very competent design office. Thus we are able to offer very complex services on the system engineering bassis. Well-developed management system, production, results achieved up to now, labor and staff structure, investment of significant founds into vocation training of our personnel, as well as the resolution of our personnel to meet all planned production targets, are warranty of further successful development of our company.

We are located in Prijedor, in the northwestern part of Bosnia and Herzegovina, only 20 miles away from the Belgrade-Zagreb highway. Since there is a railway line in the immediate vicinity of the company's premises, there are exquisitely favorable conditions for the delivery of the raw materials and finished goods to and from the company. All of the above stated has resulted in being granted licenses by the Ministries of Energy and Civil Engineering and TÜV licenses for the performing of our primary activities.

Posjedujemo proizvodnu halu cca 3000 m² sa svom neophodnom opremom (makaze za lim, tračnu pilu, hidraulične prese, mašina za kružno savijanje lima, gasni i plazma rezači, apkant presa, bušilice, aparati za zavarivanje i dr.). Takođe imamo četiri mosna kрана nosivosti 10 tona.

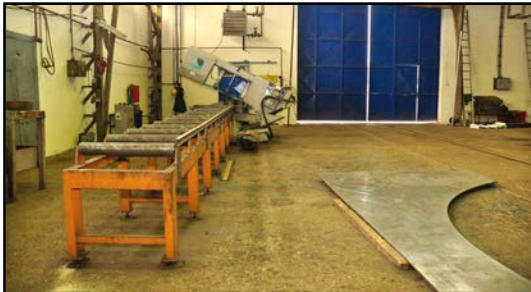

There is a production hall cca 3,000 sq.m fully equipped (shears for sheet metal, band saw blade, hydraulic press, sheet metal rolling machines, drilling machines, gas and plasma cutters, folding press, welding machines, etc). There are also four 10-ton-capacity bridge cranes.

CNC plazma rezačica sa izvorom plazme HPR 260XD, jedan plazma gorionik za obradu limova od 2 do 35mm i dva gasna gorionika za obradu limova od 2 do 200mm, dimenzije radnog stola 2x12m, sa pozicionerom za sječenje i obradom (krojenjem) cijevi.



CNC plasma cutting machine with plasma source HPR 260XD, plasma torch for processing sheets from 2 to 35mm and two gas burners for processing sheets from 2 to 200mm, the dimensions of the worktable 2x12m, with the positioner for cutting and processing tubes.

FICEP - VICTORY 11 (1101 DX) - automatska CNC mašina za bušenja profila.

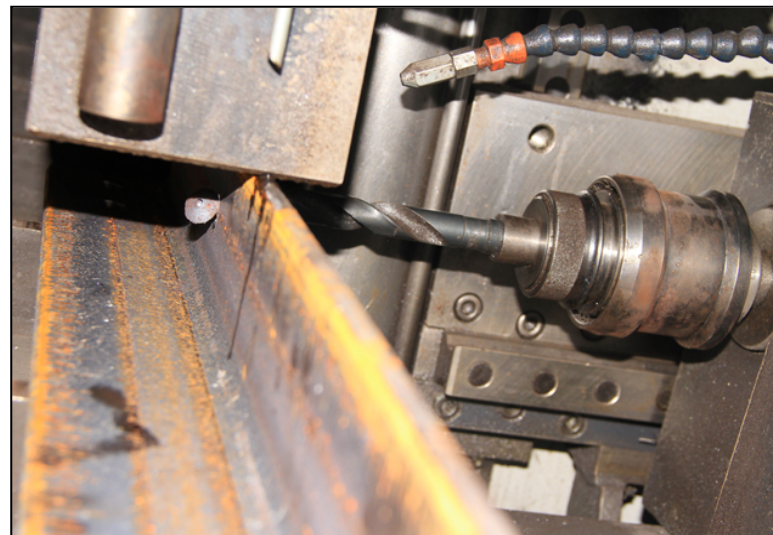

FICEP - VICTORY 11 (1101 DX) - Automatic CNC Drilling Machine.

PJESKARENJE, SAČMARENJE, AKZ

Za pripremu površina za farbanje posjedujemo sačmaru.



SAND BLASTING, SHOT BLASTING, ANTI CORROSIVE PROTECTION

For the preparation of surfaces for painting we use our own shot blasting machine.

PROIZVODNJA I MONTAŽA ČELIČNIH KONSTRUKCIJA

Osnovna proizvodna orijentacija je usmjerena na proizvodnju čeličnih konstrukcija od valjanih i limenih profila i cijevi, te izradu opreme i dijelova opreme za industriju i druge namjene.

Oprema za obradu lima i profila te za zavarivanje i kontrolu u zavarivanju omogućuju produktivnu i kvalitetnu proizvodnju.



MANUFACTURING AND ERECTION OF STEEL STRUCTURES

Basic manufacturing policy of our company is directed to the manufacturing of steel structures made of steel profiles and pipes, and the production of industrial equipment and components, and other.

Modern equipment for the processing and shaping of the sheet metal and steel profiles, a welding plant with precise quality control enable us to reach a high production rate and excellent quality products.



Hladno oblikovanje limova, izrada opreme i dijelova opreme: čeličnih silosa, posuda pod pritiskom, spremnika, ciklona, postrojenja za otprašivanje i sl. Izrada čeličnih konstrukcija raznih namjena.



Cold forming of sheet metal, manufacture of equipment and components: steel silos, pressurized vessels, containers and tanks, cyclones, dedusting plants and similar. Manufacturing of steel structures of various designs and purposes.

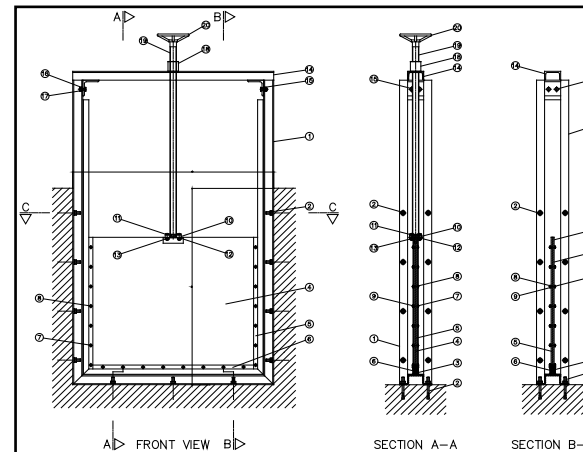

Tablasti zatvarači/Slide gate



Izmjenjivač/exchanger

ZAVARIVANJE

Zavarivanje ručno i poluautomatsko; REL, MIG, MAG, TIG, plinsko.

Radiografska i ultrazvučna kontrola zavarenih spojeva, radionička i na terenu pokretnim laboratorijama, te kontrola nepropusnosti vakuumom i tekućim penetrantima.

Obuka zavarivača u vlastitom kabinetu.



WELDING

The most modern welding methods in the following manner and with the following equipment: arc welding, MIG, MAG, TIG, gas welding.

Radiographic inspection and ultra sonic testing of welded seams in a workshop and mobile field laboratories, testing for impermeability with vacuum and liquid penetrating agents.

Training of new welders in our own training workshop.



PREFABRIKACIJA CJEVOVODA

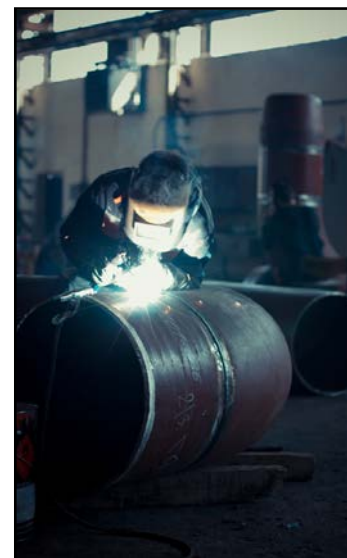

PREFABRICATION OF PIPELINES

ČELIČNA KONSTRUKCIJA

Izgradnja industrijskih, sportskih, školskih, energetskih i drugih objekata sistemom "ključ u ruke". Čelične konstrukcije proizvodnih objekata, sportskih hala, servisnih radionica, skladišnih prostora, objekata prehrambene industrije i drugih objekata predstavljaju kako u proizvodnoj tako i u montažnoj djelatnosti, najširu i najraznovrsniju aktivnost. Čelične konstrukcije cijevnih mostova, dimnjaka, mostova, benzinskih stanica i sl.

Šećerana "Brčko", BiH /sugar factory "Brčko", Bosnia and Herzegovina (2007.)



Gradska tržnica/ City Market "Banja Luka", BiH (2006.)

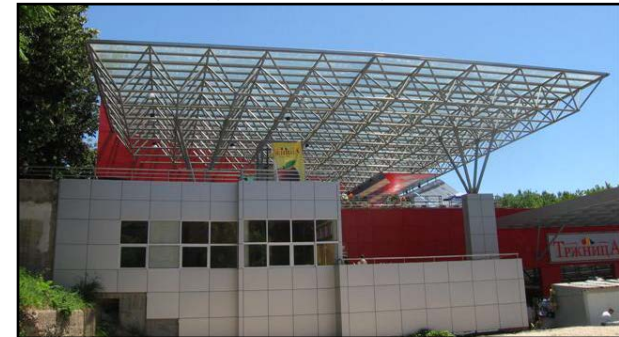

Hala/hall "Umag", Hrvatska/Croatia (2006.)

STEEL STRUCTURES

We also make industrial steel structures, sport halls, schools and other buildings and facilities on the turnkey basis. The production of steel structures for manufacturing plants, sport halls, repair & maintenance workshops, storage and warehouses, facilities of food industry and other facilities represent our company's most common and most versatile activity, both in the production, assembly and erection aspect. Steel structures for supporting bridges for pipes and pipelines, chimneys, bridges, gas stations, etc.

MONTAŽA TEHNOLOŠKE OPREME

U okviru montažne djelatnosti pored montaže čeličnih konstrukcija uspješno i dugi niz godina se bavi i montažom tehnološke opreme u industriji i montažom opreme u prehrambenoj industriji, nudeći pritom tržištu kompletne usluge montaže.

Šećerane "Požarevac" i "Kovačica", Srbija (2011.)



Sugar refinery "Požarevac" and "Kovačica", Serbia (2011.)

Rafinerija nafte "Bosanski Brod", BiH (2011.)



Oil refinery "Bosanski Brod" Bosnia and Herzegovina (2011.)

ERECTION AND INSTALLATION OF INDUSTRIAL EQUIPMENT

In addition to its activities in erection and installation of steel structures, our company has been successfully active, for many years now, in the erection and installation of the technological industrial equipment and in the erection and installation of equipment in food industry, offering the overall erection services to the market.

Tehnološka oprema za otprašivanje u industriji: filteri i cikloni u industriji cementa i livnicama, elektrofilteri za otprašivanje rude u sušarama.

Cementara "LA FARGE" Beočin, Srbija (Demontaža, izrada i montaža rashladnog tornja 2011.)



Cement plant "LA FARGE" Beočin, Serbia (Dismantling, manufacturing and assembling of cooling tower 2011.)

The technological industrial equipment for dust extraction: filters and cyclones in the cement industry and foundries, electrical filters for dust extraction from the ore in drying plants.

Rezervoari, cijevni mostovi i cjevovodi nakon izvršene izrade i montaže.

Šećerana "Donji Srem" Pećinci, Srbija - rezervoar 12000 m³ (2010.)



Sugar factory "Donji Srem" Pećinci, Serbia - tank 12000 m³ (2010.)

Storage tanks, supporting bridges for pipes and pipelines, manufacturing and erection.

TRANSPORT I MEHANIZACIJA

Sredstva za interni transport, za specijalne transporte i sredstva za dizanje (auto dizalice) svojom količinom i kapacitetom omogućuju razvoj montažne djelatnosti.

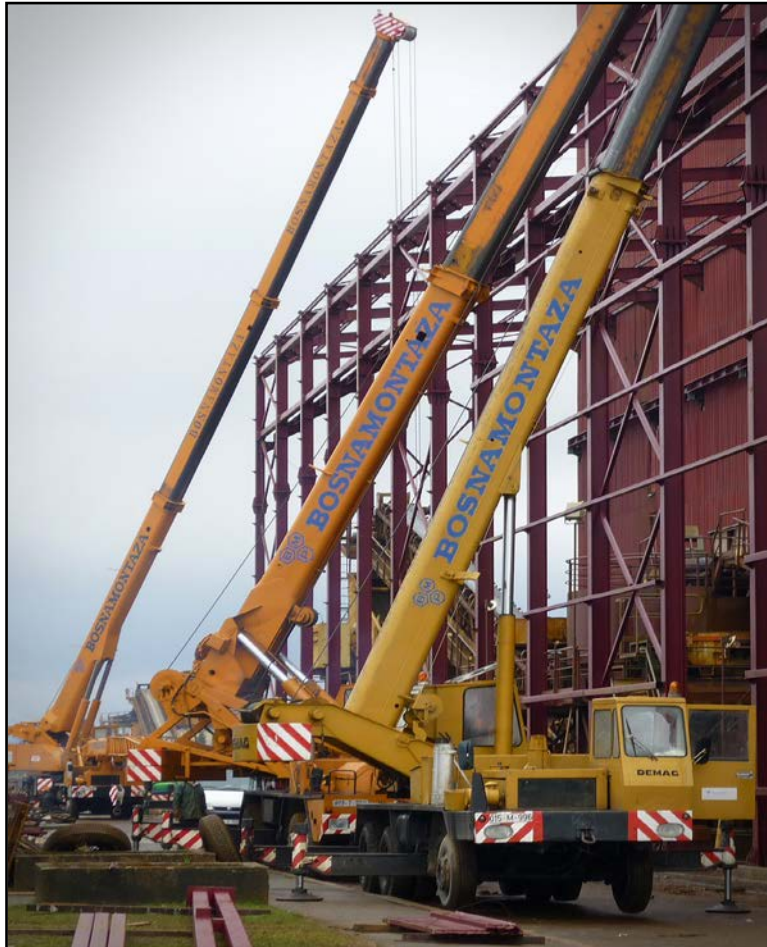

TRANSPORT AND MECHANISATION

Indoor material handling vehicles and equipment and vehicles for special transport and lifting (mobile cranes) by their quantity and capacities are providing the growth and development of erection and installation activity.

GALERIJA FOTOGRAFIJA / PHOTO GALLERY

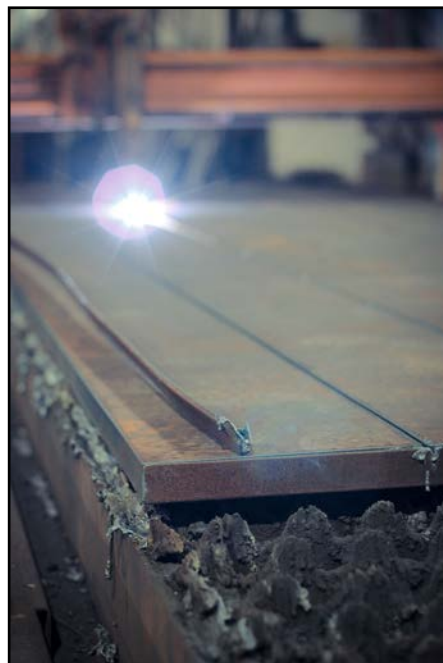
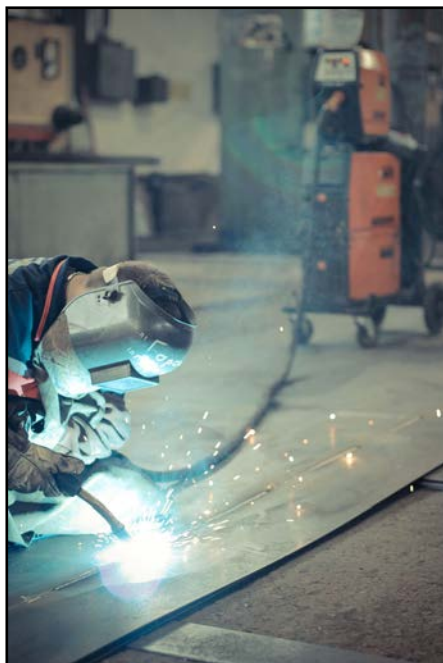







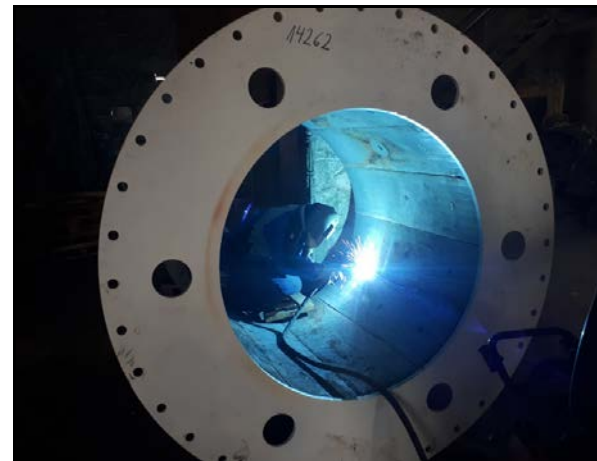

REFERENS LISTA VAŽNIJIH POSLOVA OD 2004. GODINE

U proteklih 50 godina, koliko dugo postojimo, uradili smo mnoge projekate i sakupili veoma zavidne referenc liste. Prikazaćemo samo dio projekata iz poslednjih nekoliko godina.

REDUCED REFERENCE LIST (activities since 2004)

During the last 50 years of our existence we have conducted numerous projects and co-operated with some of the most renowned clients. The table below shows only some of the projects we have conducted recently.

2004	
	Opis
	Izrada i montaža konstrukcije, Hrvatska Upravu za ceste, Hrvatska
	Remont kotlovskeg postrojenja, gradska toplana Novi Sad, Srbija
	Remont postrojenja i opreme, TE Ugljevik i TE Gacko, BiH
	Description
	Manufacturing and erection of steel structure, Croatian Roads, Croatia
	Maintenance of reservoir equipment, Heating Plant Novi Sad, Serbia
	Maintainance of reservoir equipment and maintenance of machinery, Thermal Power Plant "Ugljevik", Thermal Power Plant "Gacko" Bosnia and Herzegovina
2005	
	Opis
	Izrada i montaža cjevovoda i opreme, pivara "MB-Rodić" Novi Sad, Srbija
	Izrada čelične konstrukcije, "Hofer" Velenje, Slovenija
	Izrada i montaža tržnog centra u Gradišci, "Centrum trade" Zalužani, BiH
	Remont postrojenja i opreme, TE Ugljevik i TE Gacko, BiH
	Description
	Manufacturing of piping and new technological equipment, Brewery "MB Rodić" Novi Sad, Serbia
	Manufacturing of steel structure, "Hofer" Velenje, Slovenia
	Manufacturing and erection of steel structure, "Centrum trade" Zalužani Banja Luka, Bosnia and Herzegovina
	Maintainance of reservoir equipment and maintenance of machinery, Thermal Power Plant "Ugljevik", Thermal Power Plant "Gacko" Bosnia and Herzegovina

2006	
	Opis
	Izrada i montaža konstrukcije gradske tržnice u Banjaluci, BiH
	Izrada i montaža sportske dvorane u Umagu, Hrvatska
	Remont BTO-sistema, "Arcelor Mittal" Prijedor, BiH
	Izrada i montaža konstrukcije, "Elgrad" Lekenik, Hrvatska
	Remont i montaža opreme, šećerana Senta, Srbija
	Remont postrojenja, TE "Ugljevik", TE "Gacko" i TE "Kostolac", BiH/Srbija
	Description
	Manufacturing and erection of steel structure, City Market Banja Luka, Bosnia and Herzegovina
	Manufacturing and erection of steel structure for sport hall, Umag, Croatia
	Overhaul of mining and conveyor system, "Arcelor Mittal" Prijedor, Bosnia and Herzegovina
	Manufacturing and erection of steel structure "Elgrad", Lekenik, Croatia
	Overhaul and equipment installation, Sugar Refinery "Senta", Serbia
	Overhaul, Thermal Power Plant s "Ugljevik", "Gacko", Bosnia and Herzegovina and Thermal Power Plant "Kostolac", Serbia
2007	
	Opis
	Izrada i montaža kompletne čelične konstrukcije u šećerani u Brčkom, BiH
	Izrada i montaža postrojenja za prečišćavanje otpadnih voda, fabrika viskoze "Natron-Hayat" Maglaj, BiH
	Remont i montaža postrojenja i opreme, šećerana "TE-TO" Senta, Srbija
	Remont i montaža postrojenja i opreme, šećerana "Žabalj" i "Pećinci", Srbija
	Remont opreme i postrojenja, TE "Ugljevik", TE "Gacko", TE "Obrenovac", BiH/Srbija
	Description
	Manufacturing and erection of steel structure, Sugar Refinery Brčko, Bosnia and Herzegovina
	Works on vacuum machine B4, replacing pipelines, bypass, reconstruction of Putsch filters, "Natron Hayat", Maglaj, Bosnia and Herzegovina
	Maintenance of existing and erection of new equipment, Sugar Refinery "TE-TO" Senta, Serbia
	Maintenance of existing and assembling of new equipment, Sugar Refineries "Zabalj" and "Pecinci", Serbia
	Maintenance of reservoir equipment and maintenance of machinery, Thermal Power Plants "Ugljevik", "Gacko", BiH and Thermal Power Plant "Obrenovac", Serbia

2008	
	Opis
	Remont opreme na kotlovnici u "Mittal Steel" Zenica, BiH
	Remont i montaža postrojenja i opreme u šećerani "TE-TO" Senta, Srbija
	Izrada i montaža gradske tržnice u Istočnom Sarajevu, BiH
	Remont postrojenja u TE "Ugljevik", BiH
	Remont postrojenja u TE "Pljevlja", Crna Gora
	Montaža opreme u rafineriji "Ingolstadt", Njemačka
	Description
	Maintenance of existing and erection of new equipment "Mittal Steel" Zenica, Bosnia and Herzegovina
	Maintenance of existing and erection of new equipment, Sugar Refinery "TE-TO" Senta, Serbia
	Manufacturing and erection of steel structure, City Market, East Sarajevo, Bosnia and Herzegovina
	Maintenance of reservoir equipment and maintenance of machinery Thermal Power Plant "Ugljevik", Bosnia and Herzegovina
	Manufacturing equipment and erection of electrofilters plant, Thermal Power Plant "Pljevlja", Montenegro
	Erection of new equipment, Oil Refinery in "Ingolstadt", Germany
2009	
	Opis
	Montaža mlinova, TE "Tuzla", BiH
	Izrada stubova i ograde, "Kozaraputevi" Banja Luka, BiH
	Remont stare i montaža nove tehnološke opreme, remont i montaža novih cjevovoda i armatura, izrada i montaža čelične konstrukcije, šećerana "TE-TO" Senta, Srbija
	Nabavka materijala, AKZ, izrada i montaža nadstrešnice, "Vodovod" Prijedor, BiH
	Remont, montaža elektro filtera i dimnovodnih kanala, podkonstrukcije i stepeništa, podesti i ograde, izolacija elektrofiltera i izrada oplata za elektrofiltere, TE "Pljevlja", Crna Gora
	Remont termoelektrane, TE "Ugljevik", BiH
	Izrada prikolica, "Anvanpa Engineering" Brummen, Holandija
	Remontni radovi, TE "Gacko", BiH
	Izrada bunkera, ulaznih i izlaznih kanala, izrada platformi, stepenica i penjalica na elektrofilteru, TE "Kakanj", BiH
	Zamjena cjevnog sistema kotla i izrada dimnjaka, Rafinerija nafte "Bosanski Brod", BiH
	Izrada i montaža čelične konstrukcije hale za drobilicu, "Arcelor Mittal" Prijedor, BiH
	Description
	Installation of the mills, Thermal Power Plant "Tuzla", Bosnia and Herzegovina
	Manufacturing pillar and fences, "Kozaraputevi" Banja Luka, Bosnia and Herzegovina
	Maintenance of existing and erection of new equipment, manufacturing and erection of steel structure for Sugar Refinery "TE-TO" Senta, Serbia
	Manufacturing and erection of steel structure "Vodovod" Prijedor, Bosnia and Herzegovina
	Manufacturing equipment and erection of electrofilters plant, Thermal Power Plant "Pljevlja", Montenegro
	Maintenance of reservoir equipment and maintenance of machinery, Thermal Power Plant "Ugljevik", Bosnia and Herzegovina
	Manufacturing trailers (1,5 and 1,8 tons) and chassis for IVECO trucks "Anvanpa Engineering" Brummen, Holland
	Reconstruction of electrofilters plant and erection of new electrofilters equipment, Thermal Power Plant "Gacko", Bosnia and Herzegovina
	Manufacturing equipment and erection of filters plant Thermal Power Plant "Kakanj", Bosnia and Herzegovina
	Replacement of boiler piping and manufacturing and erection of chimney, Oil Refinery "Bosanski Brod", Bosnia and Herzegovina
	Manufacturing and erection of steel structure for crushing plants hall, "Arcelor Mittal" Prijedor, Bosnia and Herzegovina

2010	
	Opis
	Izrada i montaža rezervoara (cca330 tona) 12000 m ³ , šećerana "Donji Srem" Pećinci, Srbija
	Remont nosača međupregrijača na kotlu, TE "Ugljevik", BiH
	Remont nosača međupregrijača na kotlu, TE "Gacko", BiH
	Izrada i montaža dva rezervoara 350 m ³ , rafinerija ulja "Bimal" Brčko, BiH
	Montaža opreme i cjevovoda, šećerane: "Vrbas", "Žabalj", "Pećinci", "Crvenka", "Senta", Srbija
	Montaža cjevovoda sekcija 37, rafineriji nafte "Bosanski Brod", BiH
	Izrada konstrukcije elektro filtera, "Tegus" Zagreb, Hrvatska
	Izvođenje radova na sanaciji sekcija 31, 32 i 37, rafinerija nafte "Bosanski Brod", BiH
	Izrada i montaža čelične konstrukcije tehnološke i kablovske estakade, rafinerija nafte "Bosanski Brod", BiH
	Izrada i montaža čelične konstrukcije, krovopokrivački, građevinski, limarski i elektro radovi industrijska hala, "Arcelor Mittal" Prijedor, rudnik Omarska, BiH
	Godišnje održavanje, demontaža, montaža i remont opreme, cjevovoda i armatura, šećerana "TE-TO" Senta, Srbija
	Izrada i montaža čelične konstrukcije etažerke, rafinerija nafte "Bosanski Brod", BiH
	Čelična konstrukcija za "TGP Gradnje" Metlika, Slovenija (rafinerija nafte "Bosanski Brod"), BiH
	Description
	Manufacturing and erection of tank (approx 330 t) 12000m ³ - Sugar Refinery "Donji Srem" Pećinci, Serbia
	Superheaters carrier overhaul on boiler, Thermal Power Plant "Ugljevik", Bosnia and Herzegovina
	Superheaters carrier overhaul on boiler, Thermal Power Plant "Gacko", Bosnia and Herzegovina
	Manufacturing and erection of two tanks 350 m ³ , Edible Oil Refinery "Bimal" Brčko, Bosnia and Herzegovina
	Erection of equipment and pipelines, Sugar Refineries: "Vrbas", "Žabalj", "Pećinci", "Crvenka", "Senta", Serbia
	Erection of pipelines section 37, Oil Refinery "Bosanski Brod", Bosnia and Herzegovina
	Manufacturing of steel structure for electro filters, "Tegus" Zagreb, Croatia
	Execution of repair works, sections 31, 32, 37, Oil Refinery "Bosanski Brod", Bosnia and Herzegovina
	Manufacturing and erection of steel structure for bridge technological pipelines and power cables, Oil Refinery "Bosanski Brod", Bosnia and Herzegovina
	Manufacturing and erection of steel structure, roofing, civil works, sheet metal and electrical works on industrial hall, "Arcelor Mittal" Prijedor, Iron Ore Mine Omarska, Bosnia
	Annual maintenance, dismantling, installation and repair of equipment, piping and armature, Sugar Refinery "TE-TO" Senta, Serbia
	Manufacturing and erection of steel structure gas processing plants in Oil Refinery "Bosanski Brod", Bosnia and Herzegovina
	Manufacturing and erection of steel structure, for "TGP Gradnje" Metlika, Slovenia (in Oil Refinery "Bosanski Brod"), BiH

2011	
	Opis
	Montaža uređaja i čelične konstrukcije za a.d. šećerana "TE-TO" Senta, Srbija
	Demontaža kotlovnice (2x55t/h) u Požarevcu i montaža u šećerani "Kovačica", Srbija
	Izrada gorionika za "Enikon Mont" Zvornik (za TE "Ugljevik"), BiH
	Demontaža postojećeg, izrada i montaža novog rashladnog tornja, fabrika cementa "La Farge" Beočin, Srbija
	Zamjena stojki i interventna grupa, TE "Gacko", BiH
	Separator za kamenolome, "Ventus" Zagreb, Hrvatska
	Izrada konstrukcije i dijela opreme kao i montaža cjevovoda i opreme na postrojenju za izdvajanje benzena iz plaformata sekcije 04B, rafinerija nafte "Bosanski Brod", BiH
	Remont u livaonica željeza i radovi na remontu autoklava i drugoj opremi, željezara "Arcelor Mittal" Zenica, BiH
	Demontaža kotlovnice (1x55t/h) u Kotor Varoši i montaža u šećerani "Pećinci", Srbija
	Description
	Erection of equipment and steel structures, Sugar Refinery "TE-TO" Senta, Serbia
	Dismantling of the boiler room (2x55t/h) in Požarevac and erection in Sugar Refinery "Kovačica", Serbia
	Making burners for "Enikon Mont" Zvornik (for thermal power plant "Ugljevik"), Bosnia and Herzegovina
	Dismantling of existing, manufacture and erection of new cooling tower at the cement plant "La Farge" Beočin, Serbia
	Replacement of economizer tube support and intervention group, Termal Power Plant "Gacko", Bosnia and Herzegovina
	Separator for quarries, "Ventus" Zagreb, Croatia
	Manufacturing structures and parts of equipment, erection of piping and equipment for gas processing plant - section 04B, Oil Refinery "Bosanski Brod", Bosnia and Herzegovina
	Repair of the iron foundries and works on repair of autoclaves and other equipment in the Steel Factory, "Arcelor Mittal" Zenica, Bosnia and Herzegovina
	Dismantling of the boiler room (1x55t/h) in Kotor Varos and erection in Sugar Refinery "Pećinci", Serbia

2012	
	Opis
	Rafinerija nafte "Brod" - montaža cjevovoda - projekt "Luel"
	Rafinerija nafte "Brod" - Montaža rashodomjera sekcije 04B
	"PMP Jelšingrad" – Izrada čeličnih pozicija
	"TE-TO Senta" Srbija - remont i održavanje
	Rafinerija nafte "Brod" - remot
	Rafinerija nafte "Brod" - izrada i montaža cjevnog mosta sekcije 01 - prenos komunikacija sekcije 01
	"TE Ugljevik" - remont
	"SUNOKO" d.o.o. Novi Sad - proizvodni centar Vrbas - montaža cjevovoda i čelične konstrukcije
	"JP Elektroprivreda BiH" Sarajevo - zamjena cijevnih registara NTZ-4, bloka 6 sa zamjenom mesinganih i čeličnih cijevi
	"Arcelor Mittal" Prijedor - izrada prenosnog koša
	Šećerana "Šajkaška" Žabalj - Izrada i montaža perača CO2 gasa
	"EPS - Trebinje - RiTE Gacko" - Sanacija NTZ-4 i PS-115
	"VH-Montenegro" d.o.o. Nikšić Crna Gora - izrada i montaža čelične konstrukcije za halu
	"Venteh" d.o.o. Krško Slovenija - Izrada čelične konstrukcije elektrofiltera
	Description
	Erection of pipelines, "Luel" project in Oil Refinery "Brod", Bosnia and Herzegovina
	Oil flow meter assembling of section 04B in Oil Refinery "Brod", Bosnia and Herzegovina
	Production of steel positions for "PMP Jelšingrad", Bosnia and Herzegovina
	Overhaul in Sugar Refinery "TE-TO Senta", Serbia
	Overhaul in Oil Refinery "Brod", Bosnia and Herzegovina
	Manufacturing and erection of the pipe bridge section 01 - communications transfer of section 01, Oil Refinery "Brod", Bosnia and Herzegovina
	Overhaul in Thermal Power plant "TE Ugljevik", Bosnia and Herzegovina
	Erection of pipelines and steel structure in "SUNOKO" Ltd. manufacturing center Vrbas, Novi Sad, Serbia
	Replacement pipe registers NTZ-4, block 6 with replacement brass and steel pipes in "JP Elektroprivreda BiH" Sarajevo, Bosnia and Herzegovina
	Manufacturing of portable cage in "Arcelor Mittal", Prijedor, Bosnia and Herzegovina
	Manufacturing and erection of CO ₂ gas washer in Sugar Refinery "Šajkaška" Žabalj, Serbia
	Repair works on heat exchangers NTZ-4 i PS-115, "EPS - Trebinje - RiTE Gacko", Bosnia and Herzegovina
	Manufacturing and erection of steel structure for the hall, "VH-Montenegro" Nikšić, Monte Negro
	Manufacturing steel structure for electro filters for "Venteh" Krško, Slovenia

2013	
	Opis
	Izrada, AKZ-a i montaža metalnih konstrukcija cijevnog mosta za tehnološke cjevovode, montaža opreme i tehnoloških cjevovoda na Komunikacijama između fabričkih pogona (Naslov 100-08) i Rezervoarima baznih ulja (Naslov 100-02) po projektu "Novi kompleks za sjedinjavanje ulja za podmazivanje" u Rafineriji ulja – Modriča
	Godišnji remont i održavanje postrojenja fabrika šećera TE-TO Senta
	Izrada i montaža rezervoara za melasu V=12000 m ³ u šećerani Sunoko – Pećinci
	Remontni radovi na termoelektrani Gacko
	Demontaža u Zrenjaninu, transport i montaža u Pećincima silosa V=45000m ³ za šećer u šećerani Sunoko, Pećinci, Srbija
	Isporuka i ugradnja sistema otprašivanja na Tercijalnom postrojenju rudnika Arcelor Mittal Omarska, Prijedor
	TE Stanari – Montaža rezervoara za sirovu vodu 5000m ³ ,
	Description
	Manufacturing, anticorrosive protection and erection of steel structure for bridge for technological pipelines, erection of equipment and technological pipelines of communication between the factory unit (Title 100-08) and reservoir of base oils (Title 100-02) by project "The new complex for the compounding of oil for lubrication" in Oil Refinery "Brod", Bosnia and Herzegovina
	Annual overhaul and maintenance, Sugar Refinery "TE-TO" Senta, Serbia
	Manufacturing and erection of tanks for sugar molasses, V=12000 m ³ in Sugar Refinery "SUNOKO" Pećinci, Serbia
	Overhauling works, Thermal Power Plant Gacko Bosnia and Herzegovina
	Dismantling sugar silo V=45000m ³ in Zrenjanin, transportation and installation in Sugar Refinery "SUNOKO" Pecinci, Serbia
	Delivery and installation of dedusting system for Tertiary plant of Iron Ore Mine Arcelor Mittal Omarska, Prijedor
	Erection of raw water tank 5000m ³ in Thermal Power Plant Stanari, Bosnia and Herzegovina

2014	
	Izrada i montaža čelične konstrukcije postrojenja filter prese GMS-a i montaža opreme filter prese u rudniku Arcelor Mittal Omarska
	Ugradnja dvostepene EMS za tretman dijela pijeska klasifikatora u rudniku Arcelor Mittal Omarska
	Izrada i montaža čelične konstrukcije za realizaciju projekta izrade cevastog transporter – SSW faza 2, fabrika cementa "La Farge BFC" Beočin, Srbija
	Izrada i montaža novog postrojenja za otprašivanje na novoj EPP peći (kanali, klapne, vrećasti filteri, sistem transporta prašine, silosi, ventilatori i pripadajuće servisne platforme) u tvornici RS-Silicon, Mrkonjić Grad
	Instalacija 36MVA peći za silicijummetal, svih komponenata za montažu, montaža čelične konstrukcije peći, istovar sve opreme, komponenata i materijala, logističko upravljanje svom opremom, komponentama i materijalom u tvornici RS-Silicon, Mrkonjić Grad
	Rekonstrukcija sistema za stvaranje vakuma sekcije 31 i sanacija krova na rezervoarima B-97 i S-40, "ZNSM-BLK" d.o.o. Brod i Rafinerija nafte Brod
	Izrada i montaža čelične konstrukcije za tehnološke cjevovode na komunikacijama između fabričkih pogona po projektu "Novi kompleks za sjedinjavanja ulja za podmazivanje", rafinerija ulja Modriča
	Rekonstrukcija cjevovoda, spajanje turbine 7,5 MW u tehnološku cjelinu kao i ugradnja filtera krečnog soka te godišnji remont i održavanje "TE-TO Senta" Srbija
	Nabavka usluga izrade i zamjene kanala ugljenog praha u rudniku i termoelektrani Ugljevik
	Rekonstrukcija trakta dimnih gasova kotlovsog postrojenja, za potrebe remonta kao i radiografska kontrola zavarenih spojeva – remont u Rudniku i termoelektrani Gacko
	Description
	Manufacturing and erection of steel structure for filter press in GMS (gravity magnetic separator) plant and installation of equipment of filter press in iron ore mine Arcelormittal Omarska
	Installation of the two step EMS (electromagnetic separator) for treatment of part of ore sand from the classifier in iron ore mine Arcelormittal Omarska
	Manufacturing and installation of steel structures for the project of making tubular conveyors – SSW phase 2, cement Factory "La Farge BFC" Beočin, Serbia
	Manufacturing and erection of new dedusting plant on new Electric arc Furnace (ducts, dampers, bag filters, system of dust transportation, silos, heat exchanger, fans, appropriate platforms for servicing) in Si Metal factory RS Silicon, Mrkonjic Grad
	Installation of 36 MVA Si metal furnace and all the components, erection of furnaces steel structure, unloading of complete equipment, components and materials, logistics management of all equipment, components and materials in the Si metal factory RS-Silicon, Mrkonjić Grad
	The reconstruction of system for the creation of vacuum in section 31 and roof repairs on tanks B-97 and S-40, "ZNSM-BLK" Ltd Brod and Oil Refinery Brod
	Manufacturing and erection of steel structures for technological pipelines on communications between factory plants by project "The new complex for the compounding of oil for lubrication", Oil refinery Modrica
	The reconstruction of pipeline, binding the turbine of 7.5 MW in the technological unit and, also, installation of filter for calx juice and annual overhaul and maintenance in "TE-TO Senta" Serbia
	Supply, manufacturing and replacement of coal dust duct in Mine and Thermal Power Plant Ugljevik
	Reconstruction of tract of flue gas from boiler plant, for the purposes of overhaul, as well as radiographic testing of welds - overhaul in Mine and Thermal Power Plant Gacko

2015	
	Izrada čelične konstrukcije i transportera u cementari Lafarge Beočin, Srbija
	Montaža glavne zgrade (proizvodne zgrade) i tehnološke opreme za fabriku RS Silikon Mrkonjić Grad -3000 t konstrukcije i opreme, BiH
	Montaža čelične konstrukcije, transportnog sistema, mlinova (drobilica) i ostale opreme u R-S Silicon d.o.o. Mrkonjić Grad za italijansku firmu OM Siderurgica, BiH
	Izrada i montaža filterskog postrojenja za Ivicom (Boldrocchi Italija) za fabriku R-S Silikon -700 t
	Remontni radovi u TE Gacko, BiH
	Remont i održavanje u TE-TO Senta (zamjena visokopritisnog cjevovoda i remont tehnološke opreme (izmjenjivača, difuzije, presa...) Srbija
	Sanacija (zamjena dijela plašta i krova) rezervoara B97 u rafineriji nafte Brod, BiH
	Sanacija difuzije RT-4 u a.d. fabrika šećera "Šajkaška" Žabalj, Srbija
	Remont bubnja za pranje rude u Arcelor Mittal Prijedor, BiH
	Izrada sistema deponovanja mulja u PK jezero u Arcelor Mittal Prijedor, BiH
	Nabavka i instalacija vrelovoda DN350, izrada i montaža kanala, izrada hale za lagerovanje bio mase u novoj toplani u Prijedoru, BiH za Urbas Maschinenfabrik GmbH, Austrija
	Montaža konstrukcije livne platforme i bunkera u Arcelor Mittal Zenica, BiH
	Izrada komplet energane na bio masu kapaciteta od 2x14MW za DES Danish Energy Systems, Danska
	Description
	Manufacturing of steel structure and conveyors in the cement Factory "La Farge BFC" Beočin, Serbia
	Erection of the main building(production building) and technological equipment in factory RS Silikon d.o.o. Mrkonjić Grad – 3000 tons of steel structure and equipment, Bosnia and Herzegovina
	Erection of steel structure, conveying systems, mills(crushers) and other equipment in factory R-S Silicon d.o.o. Mrkonjić Grad for Italian Company OM Siderurgica, Bosnia and Herzegovina
	Manufacturing and erection of dedusting plant for Ivicom(Boldrocchi Italy) in factory RS Silikon d.o.o. Mrkonjić Grad, Bosnia nad Herzegovina – 700 tons
	Overhauling works, Thermal Power Plant Gacko Bosnia and Herzegovina
	Overhaul and maintenance in Sugar Refinery "TE-TO" Senta (replacement of high-pressure pipelines and repair of technological equipment (exchangers, diffusion, press ...)
	Repair (replacement of one part of tank shell plates and replacement of the roof) of tank B97 in Oil Refinery Brod, Bosnia and Herzegovina
	Repair of diffusion RT-4 in Sugar Factory "Šajkaška" a.d. Žabalj, Serbia
	Overhaul of the drum for the washing of iron ore in ArcelorMittal Prijedor, Bosnia and Herzegovina
	Production of a system for the deposit of silt in the "PK" lake (lake of surface mine) in ArcelorMittal Prijedor, Bosnia and Herzegovina
	Supply and installation of hot water pipeline DN350, manufacture and installation of ducts, manufacture of the hall for the storage of biomass in new Heating Plant in Prijedor, Bosnia and Herzegovina, for Urbas Maschinenfabrik GmbH, Austria
	Erection of steel structure of the casting platform and bunkers in ArcelorMittal Zenica, Bosnia and Herzegovina
	Manufacturing of complete power plant(water tube boilers on biomass) with capacity of 2x14 MW, for Danish Energy Systems A/S, Denmark

2016	
	Radovi na sanaciji gasovazdušnog trakta kotlovskeg postrojenja u TE Gacko, BiH.
	Izrada i zamjene kanala ugljenog praha, remont ventilatora dimnih plinova, zamjena ventilatora hladnog gasa sa zamjenom temelja i spajanje u funkcionalnu cjelinu, remont odlagača uglja sa zamjenom točkova, remont dozatora i dodavača u TE Ugljevik, BiH.
	Nabavka materijala i izrada čelične konstrukcije za industrijske mašine Springer, Austrija.
	Izvođenje radova na povećanju proizvodno-tehničke mogućnosti izmjenjivača (zamjena cjevnog snopa izmjenjivača) u rafineriji ulja Modriča, BiH.
	Zamjena (demontaža, priprema, izrada i montaža) cjevovoda pumpi i zgušnjivača u Arcelor Mittal Prijedor, BiH.
	Mašinski radovi na zamjeni (demontaža, montaža, centriranje i zavarivanje) nosivog prstena rotacione peći zajedno sa dijelom plašta i cementari Titan Kosjerić, Srbija.
	Montaža konstrukcije livne platforme i bunkera u Arcelor Mittal Zenica, BiH.
	Demontaža silosa šećera kapaciteta 40000t u šećerani u Crnji, transport i montaža u šećerani u Kovačici, Sunoko Srbija.
	Izrada i montaža dekantera, rezervoara filtrata, rezervoara mulja i cjevovoda na stanici čišćenja soka u fabrici šećera Crvenka, Srbija.
	Remontni radovi u rafineriji nafte Brod, BiH.
	Sanacija pregrijača pare na kotlu Đuro Đaković, šećerana Kovačica, Srbija.
	Zamjena dijelova bubnja sušare kristala, demontaža prstenova, zupčastog vijenca i pogonskog zupčanika u Baču, transport u Kovačicu te montaža prstenova i zupčastog točka u šećerani Kovačici, Srbija.
	Description
	Works on repair of tract (ducts) for gas and air in boiler plant in TPP Gacko, Bosnia and Herzegovina.
	Production and replacement of ducts for pulverized coal, overhaul of flue gas fans, replacing of fans of cold gas with the replacement of the foundations and merging into a functional unit, overhaul of coal disposal unit including replacement of wheels, overhaul of the doser and feeder in TPP Ugljevik, Bosnia and Herzegovina.
	Supply of material and production of steel structures for industrial machines for Springer, Austria.
	Works on the increase of production and technical possibilities of heat exchanger (replacement of the tube bundle in exchanger) Oil Refinery Modrica, Bosnia and Herzegovina.
	Replacement (disassembly, preparation, fabrication and installation) of pump pipeline and of the thickener in ArcelorMittal Prijedor, Bosnia and Herzegovina.
	Mechanical works on the replacement (disassembly, assembly, alignment and welding) of tyre station on the cement Kiln together with the part of the casing in the Cement Factory Titan Kosjerić, Serbia.
	Erection of steel structure of the casting platform and bunkers in ArcelorMittal Zenica, Bosnia and Herzegovina.
	Dismantling of silos for sugar of capacity 40000 tons in sugar refinery in Crnja, transport of dismantled parts of silos from Crnja to Kovačica and erection in a Sugar Refinery in Kovačica, company Sunoko, Serbia.
	Production and erection of a decanter, filtrate tanks, sludge tanks and the pipeline on the cleaning station for the juice in a Sugar Refinery Crvenka, Serbia.
	Overhaul works at the Oil Refinery in Brod, Bosnia and Herzegovina.
	Repair of steam superheater on boiler "Đuro Đaković" in Sugar Refinery Kovačica, Serbia.
	Replacement of parts of the drier drum for sugar crystals, dismantling of the rings, gear and pinion gear rim in Bač, transportation to Kovačica and the installation of these parts in the Sugar Refinery Kovačica, Serbia.

2017	
	Izrada i montaža kanala, Fusche kruje cement Factory – Albanija
	Popravka i zamjena izlaznog dijela sekcije peći za cement sa novim, uključujući prsten za hlađenje, zaptivku i livene dijelove Fusche kruje cement Factory – Albanija
	Izrada i montaža cijevnog mosta, Rafinerija nafte Brod, BiH
	Sanacija gasovazdušnog trakta kotlovskeg postrojenja, TE Gacko, BiH
	Demontaža i montaža BW difuznog tornja, Fabrika šećera "Šajkaška" Žabalj, Srbija
	Izrada i montaža novog unutrašnjeg plivajućeg krova, Rafinerija nafte Brod, BiH
	Demontaža, izrada i montaža pregrijača pare, Sunoko, Novi Sad, PC Vrbas, Srbija
	Zamjena kanala dimnih plinova, remont kanala ugljenog praha i gorionika, remont mlinskog postrojenja, remont međupregrijala pare, TE Ugljevik, BiH
	Demontaža, nabavka materijala, izrada, isporuka i montaža izlaznih kanala dimnog gasa Euro mont ing. Beograd za TE Ugljevik, BiH
	Izrada čelične konstrukcije, Springer Austrija
	Rekonstrukcija sušare rezanaca na ugalj, bubanj 1 i 2, Sunoko Novi Sad, PC Vrbas, Srbija
	Izrada i montaža plašta apsobera, montaža pomoćnog rezervoara, potporne konstrukcije vlažnog dimnjaka i čelične konstrukcije pumpne stanice, Rudis Trbovlje za TE Ugljevik, BiH
	Zamjena cijevi ekonomizera kotla, Rafinerija ulja Modriča, BiH
	Godišnji remont postrojenja, Silikon Mrkonjić Grad, BiH
	Godišnji remont postrojenja, Rafinerija nafte Brod, BiH
	Description
	Production and erection of downcomer ducts, Fusche Kruje Cement Factory – Albania
	Repair/Replacement of the Outlet section part of the Kiln with new ones, including cooling ring, outlet seal and cast parts Fusche kruje cement Factory – Albanija
	Production and erection of Pipe Bridge, Oil Refinery in Brod, Bosnia and Herzegovina.
	Works on repair of tract (ducts) for gas and air in boiler plant in TPP Gacko, Bosnia and Herzegovina.
	Dismantling and installation of BW diffusion tower, Sugar Refinery "Šajkaška" Žabalj, Serbia
	Production and assembly of a new internal floating roof in reservoir, Oil Refinery Brod, Bosnia and Herzegovina.
	Dismantling, production and installation of steam superheater, Sunoko, Novi Sad, Serbia.
	Replacement of the flue gas ducts, overhaul of coal dust ducts and burners, overhaul of the mill plant, overhaul of the intermediate steam superheater, TPP Ugljevik, Bosnia and Herzegovina.
	Dismantling, procurement of materials, production, delivery and erection of flue gas outlet ducts in TPP Ugljevik, Bosnia and Herzegovina, for Euromonting Belgrade.
	Production of steel structure for Springer Maschinenfabrik GmbH Austria.
	Reconstruction of coal drying plant, the drum 1 and 2, Sunoko Novi Sad, Serbia.
	Production and erection of the absorber shell, erection of an auxiliary tank, support structure of the humid stack and steel structure of the pump station for Rudis Trbovlje in TPP Ugljevik, Bosnia and Herzegovina
	Replacement of the tubes of the boiler economizer, Oil Refinery Modriča, Bosnia and Herzegovina.
	Annual overhaul of the plant, RS Silikon, Mrkonjic Grad, Bosnia and Herzegovina.
	Annual overhaul of the plant, Oil Refinery Brod, Bosnia and Herzegovina.

2018	
	Izrada i montaža čelične konstrukcije iznad silosa gipsa, Rudis Trbovlje za TE Ugljevik, BiH
	Montaža opreme u i oko Apsorbera, Rudis Trbovlje za TE Ugljevik, BiH
	Izrada cijevnih zmijsa ekonomajzera- Global ispat koksna industrija Lukavac, BiH
	Remontni radovi na posudama pod pritiskom i izmjenjivačima, Rafinerija nafte Brod, BiH
	Godišnji remont postrojenja, RS Silikon Mrkonjić Grad, BiH
	Izrada i montaža AB/LCL kolone i pripadajućih cjevovoda, Sisecam soda Lukavac, BiH
	Montaža vakum aparata „Forman“, Fabrika šećera Crvenka, Srbija
	Sanacija difuzije RT-4, Fabrika šećera Žabalj, Srbija
	Zamjena cjevovoda i dotrajalih limova na pripremi proizvodnje, Fabrika šećera Žabalj, Srbija
	Sanacija gasovazdušnog trakta kotla P-64, TE Gacko, BiH
	Izrada i montaža kanala dimnih gasova od kotla do ekonomajzera, Rafinerija nafte Brod, BiH
	Rekonstrukcija skladišta i zagrijavanja mazuta, Titan cementara Kosjerić, Srbija
	Description
	Manufacturing and erection of steel structure above silo of gypsum, Rudis Trbovlje for TPP Ugljevik, Bosnia and Herzegovina.
	Erection and installation of equipment in and around the Absorber, Rudis Trbovlje for TPP Ugljevik, Bosnia and Herzegovina.
	Manufacturing of economizer coils for economizer - Global Ispat coke industry Lukavac, Bosnia and Herzegovina.
	Overhaul works on pressure vessels and heat exchangers, Oil Refinery Brod, Bosnia and Herzegovina.
	Annual overhaul of the plant, RS Silikon Mrkonjic Grad, Bosnia and Herzegovina.
	Manufacturing and installation of AB / LCL column and associated pipelines, Sisecam Soda Lukavac, Bosnia and Herzegovina.
	Erection of vacuum apparatus „Forman“, Sugar Refinery Crvenka, Serbia.
	Repair works on Diffusion RT-4, Sugar Refinery Žabalj, Serbia.
	Replacement of pipelines and worn-out plates on production preparation department, Sugar Refinery Žabalj, Serbia.
	Works on repair of tract (ducts) for gas and air in boiler P-64, TPP Gacko, Bosnia and Herzegovina.
	Manufacturing and erection of flue gas ducts from the boiler to the economizer, Oil Refinery Brod, Bosnia and Herzegovina.
	Reconstruction of warehouse and system for preheating of fuel oil, Cement Factory Titan Kosjerić, Serbia.

RJEŠENJA, SERTIFIKATI I LICENCE KOJE POSJEDUJE "BOSNAMONTAŽA" a.d. PRIJEDOR
CERTIFICATES AND LICENCES THAT OWNS "BOSNAMONTAŽA" a.d. PRIJEDOR

- CERTIFIKAT ISO 9001:2015 od TÜV Thüringen - Njemačka
CERTIFICATE ISO 9001:2015 from TÜV Thüringen – Germany
- CERTIFIKAT EN ISO 3834-2 od TÜV Adria - Njemačka
CERTIFICATE EN ISO 3834-2 from TÜV Adria – Germany
- CERTIFIKAT EN 1090-1:2012 od TÜV Thüringen - Njemačka
CERTIFICATE EN 1090-1:2012 from TÜV Thüringen – Germany
- CERTIFIKAT EN 1090-2:2008+A1:2011 od TÜV Thüringen – Njemačka
CERTIFICATE EN 1090-2:2008+A1:2011 from TÜV Thüringen – Germany
- CERTIFIKAT ISO 14001:2015 i OHSAS 18001:2007 od TÜV Thüringen – Njemačka
CERTIFICATE ISO 14001:2015 and OHSAS 18001:2007 from TÜV Thüringen – Germany
- Directive 97/23/EC (PED), EN 12952-5, EN 13445-4 i EN 13480-4 od TÜV Thüringen – Njemačka
Directive 97/23/EC (PED), EN 12952-5, EN 13445-4 i EN 13480-4 from TÜV Thüringen – Germany
- Licenca Ministarstva prostornog uređenja, građevinarstva i ekologije za izradu čelične konstrukcije i mašinskih instalacija na objektima
Licence from Ministry of spatial planing, construction and ecology for manufacturing and erection of steel structures and mehanical installation
- Licenca Ministarstva prostornog uređenja, građevinarstva i ekologije za izradu dijela tehničke dokumentacije
Licence from Ministry of spatial planing, construction and ecology for designing the steel structures
- Rješenje Ministarstva industrije, energetike i rudarstva za obavljanje djelatnosti ispitivanje bez razaranja
Decision from Ministry of industry, energy and mining for examination of welded seam without destroying
- Rješenje Ministarstva industrije, energetike i rudarstva za obavljanje djelatnosti bravarsko zavarivačkih radova na izradi, montaži, sanaciji i remontu energetske opreme pod pritiskom
Decision from Ministry of industry, energy and mining for locksmith's and welding works on manufacturing ,erection, repair and overhaul of power plants and pressurised equipment
- Rješenje Ministarstva industrije, energetike i rudarstva za obavljanje djelatnosti izrade i montaže posuda pod pritiskom
Decision from Ministry of industry, energy and mining for manufacturing and erection of presurised equipment
- Rješenje Ministarstva industrije, energetike i rudarstva za montažu gasnih instalacija
Decision from Ministry of industry, energy and mining for erection of gas installations
- Rješenje Ministarstva prostornog uređenja, građevinarstva i ekologije o ispunjenosti uslova za izvođenje čeličnih konstrukcija i mašinskih instalacija
Decision from Ministry of spatial planing, construction and ecology on fulfillment of the conditions for manufacturing and erection of steel structures and mechanical installations
- Rješenje Ministarstva industrije, energetike i rudarstva o ispunjenosti uslova za obuku i atestaciju zavarivača i nadzor nad obavljanjem zavarivačkih radova
Decision from Ministry of spatial planing, construction and ecology on fulfillment of the conditions for training the welders and certification of welders and supervision of welding process
- Rješenje Ministarstva industrije, energetike i rudarstva za izradu mašinskih instalacija
Decision from Ministry of industry, energy and mining for manufacturing of mechanical installations



Bosnamontaža A.D.

PRIJEDOR

PREDUZEĆE ZA MONTAŽNO PROIZVODNE I USLUŽNE DJELATNOSTI
COMPANY FOR PRODUCTION, ERECTION AND SERVICE ACTIVITIES

Rudnička bb | 79101 Prijedor, BiH | <http://www.bosnamontaza.com> | office@bosnamontaza.com

Direktor

Managing Director

Mob: +387(0)65/520-074
Tel: +387(0)52/234-266
Fax: +387(0)52/233-060
E-mail: darkozdjelar@teol.net

Tehnička priprema

Engeneering

Tel: +387(0)52/233-683
E-mail: tehnicka.priprema@bosnamontaza.com

RJ Montaža

Assembly

Tel/Fax: +387(0)52/215-444
E-mail: info@bosnamontaza.com
montaza@bosnamontaza.com
dusko.andjic@bosnamontaza.com

RJ Transport

Transportation

Tel: +387(0)52/234-785
E-mail: transport@bosnamontaza.com

Služba nabave

Supply

Tel/Fax: +387(0)52/232-287
E-mail: nabava@bosnamontaza.com

Kadrovska služba

Human Resources

Tel: +387(0)52/232-680
E-mail: kadrovska.sluzba@bosnamontaza.com

Finansijska i knjigovodstvena služba

Finance and Accountancy

Tel: +387(0)52/233-677
E-mail: racunovodstvo@bosnamontaza.com

Kontrola kvalitete

Quality control

Tel: +387(0)52/233-480
E-mail: kontrola@bosnamontaza.com

Zavarivanje

Welding

Tel: +387(0)52/233-480
Fax: +387(0)52/233-060
E-mail: zavarivanje@bosnamontaza.com

Pravna služba

Legal Service

Tel: +387(0)52/232-680
E-mail: pravna.sluzba@bosnamontaza.com

PIB/VAT No.: 400669420008

JIB/ID No.: 4400669420008

Matični broj/Registration number: 1157124

